

Penn State Altoona



Campus Exterior Architectural Plan
September 2008

Contents

Introduction and Purpose

Existing Conditions Inventory

Improvement Recommendations

BUILDINGS

- ① Misciagna Family Center for the Performing Arts
- ② Elm Building
- ③ Cedar Hall
- ④ Oak Hall
- ⑤ Slep Student Center
- ⑥ Housing and Food Services Building
- ⑦ Maple Hall
- ⑧ Bookstore Building
- ⑨ Adler Athletic Complex
- ⑩ Edith Davis Eve Chapel
- ⑪ Spruce Hall
- ⑫ Hemlock Building
- ⑬ Pine Building
- ⑭ Smith Building
- ⑮ Eiche Library
- ⑯ Science Building
- ⑰ Holtzinger Engineering Building
- ⑱ Force Advanced Technology Center
- ⑲ Maintenance Building
- ⑳ Cypress Building
- ㉑ M&O Operations Building
- ㉒ Landscape Storage Building
- ㉓ Willow Building
- ㉔ Police Services Garage
- ㉗ Press Box
- ㉘ M & O Storage Building
- ㉙ Baker Barbecue Pit
- ⑳ Environmental Resources Lab
- ㉛ Sheetz Family Health Center
- ㉜ Birch Complex
- ㉝ Linden Building
- ㉞ Theatre Arts Studio
- ㉟ Hawthorn Building
- ㊱ Laural Pavilion
- ㊲ Spring Run Stadium Press Box
- ㊳ Larch House
- ㊴ Beech House

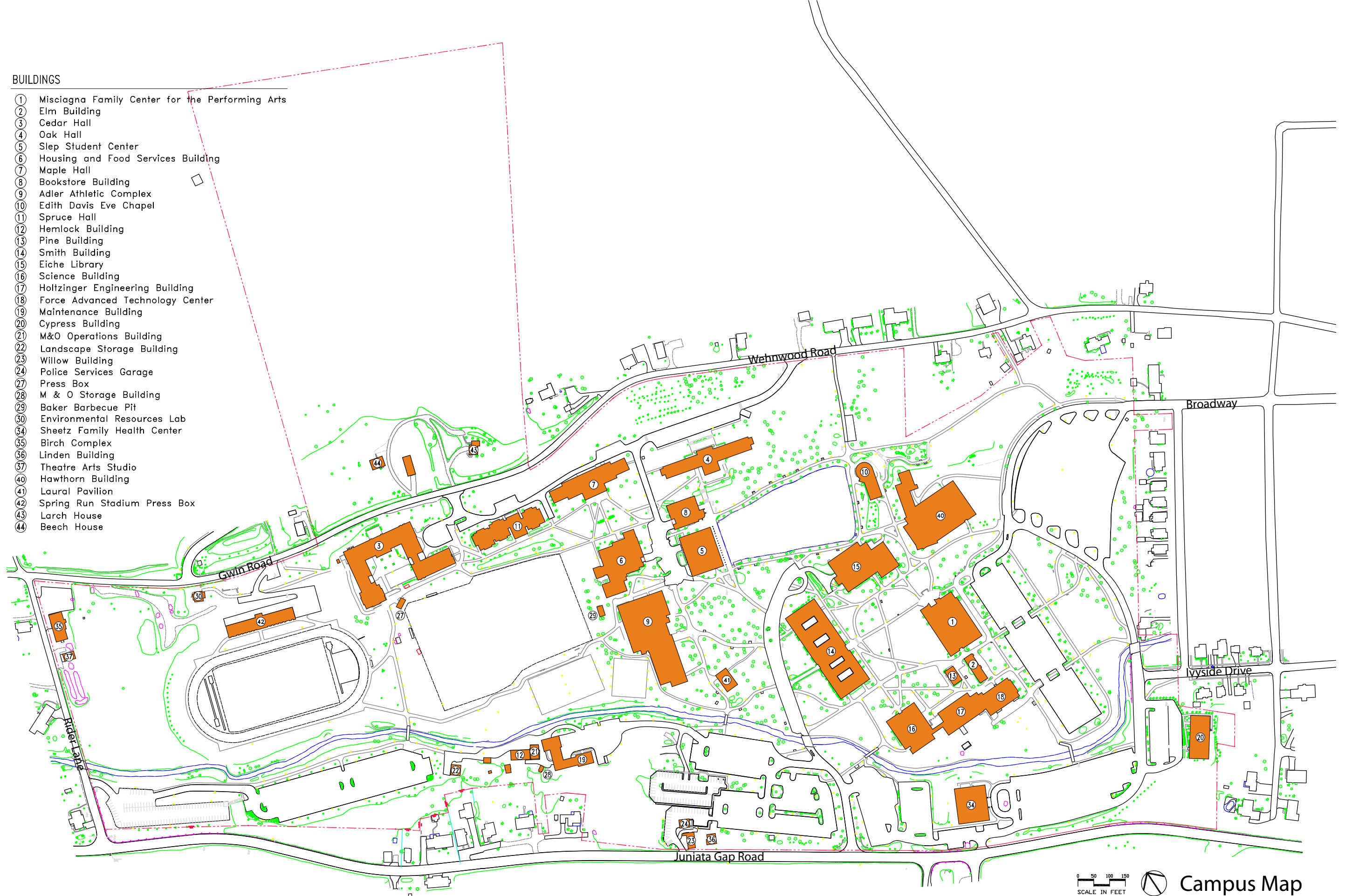

Introduction and purpose

Penn State's Mission:

Penn State is a multi-campus public land-grant university that improves the lives of the people of Pennsylvania, the nation, and the world through integrated, high-quality programs in teaching, research, and service.

To assist in achieving this mission, a Campus Exterior Architecture Plan, known as a CEAP, is developed to suggest ways to improve the exterior aesthetic qualities of campus with low-cost and easy-to-implement concepts that can have meaningful impacts. The CEAP is a planning tool that is an outgrowth of the campus master planning process.

The CEAP includes graphic and narrative descriptions of existing conditions on campus and approximately 15-20 improvement concepts. Positive features may also be identified as elements to emulate.

The improvement concepts are ranked or prioritized according to their visual impact and estimated cost. The concepts are not final designs. Further study and design are required prior to implementation.

Existing Conditions Inventory

Background:

A detailed site analysis, campus vision and future development strategy are fully documented in the campus master plan process. In addition to the analysis performed during the master planning process, a focused visual assessment of the campus exterior is conducted which establishes the foundation for the recommendations and concepts contained in this CEAP document.

General Observations:

The campus occupies a site historically developed as Ivyside Park on 38 acres of land once considered the outskirts of the City of Altoona. Steady growth of the campus and surrounding residential neighborhoods have resulted in the now 150 acre academic and community asset of today. The campus has incorporated features of its park origins most notably the pond at the Slep Student Center. This amenity is a landmark for the campus as well as the entire regional community.

Stands of mature trees are abundant providing a loose framework for the development of meandering walkways enjoyed by students, faculty, staff and the public. Passive and active recreational opportunities are abundant campus wide. There is opportunity for additional improved outdoor gathering spaces for organized activities.

Pedestrian circulation in the campus core is functional however the opportunity exists to modify alignments and materials to unify buildings and better organize exterior space. In addition, maintenance, operational and environmental efficiencies could be realized by consolidating and reducing unnecessary, redundant and excessive paved surfaces. Parking facilities are adequate and suitably located on the campus perimeter with few exceptions.

Quality athletic facilities, student residences and performance venues at the campus have spawned a dynamic living and learning environment.



Architecture

Existing Conditions Inventory

Major architectural modifications, additions, and new construction are beyond the scope of this CEAP. However, the aesthetic character of campus is defined to a great extent by the structures that comprised it. Brick masonry is the predominant building material used to construct most buildings on campus.



Site Furnishings

Existing Conditions Inventory



Benches, trash receptacles tables and bike racks across the campus are varied in design, color and material.



It is recommended that a standard design for furnishings be selected that will aid in unifying the campus aesthetic.

In addition to aesthetic appropriateness, the longevity and maintenance of site furnishings should be considered when specifying.



Lighting

Existing Conditions Inventory

A variety of exterior light fixture types are present on campus. As with site furnishings, it is recommended that design standards for parking lot/roadway and pedestrian site lighting be identified and implemented across campus. Full Cut-off luminaires that mitigate light pollution should be used. Metal Halide lamps on pedestrian walkways is recommended.



Signage

Existing Conditions Inventory

Consistent design and placement of directional and identification signs is key to a unified aesthetic as well as an intuitive and clear means of way finding.

Consistent utilization of Penn State graphic standards throughout the system builds the University's identity.

Signage upgrades prompted by CEAP

recommendations made at other Commonwealth campuses has resulted in a complete renovation program at Altoona as well. The program is currently in the final approval stage with implementation to follow.

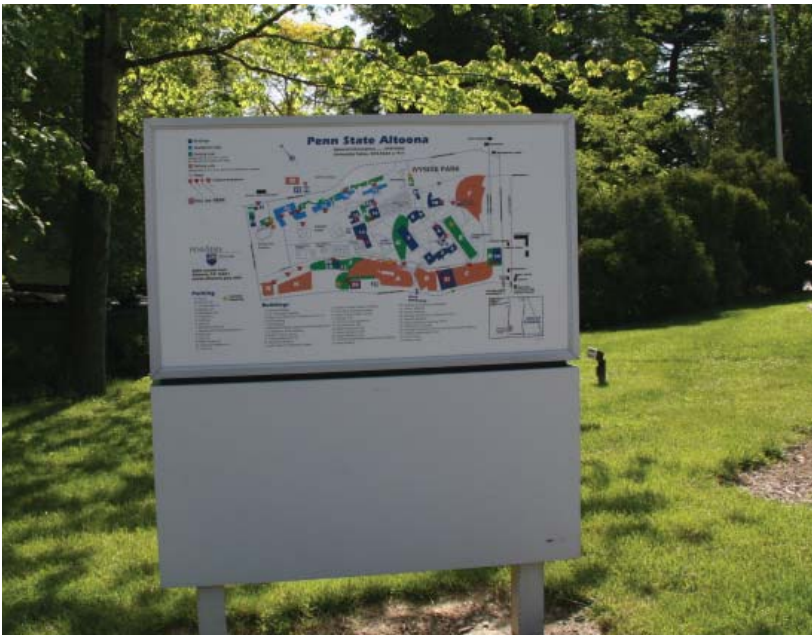



Landscape

Existing Conditions Inventory

The landscape aesthetic of the campus can be characterized as park-like with meandering walkways threaded through groves of large, quality specimen trees. Ornamental plantings are conservative and well maintained. Mature wooded areas should continue be protected from development. Any and all invasive plant species should be eradicated.

Opportunities exist for the limited use of perennial and annual flower color. Turf areas appear to be weed-free and well maintained.

Both formal and informal outdoor gathering spaces exist on campus though there is opportunity for more.

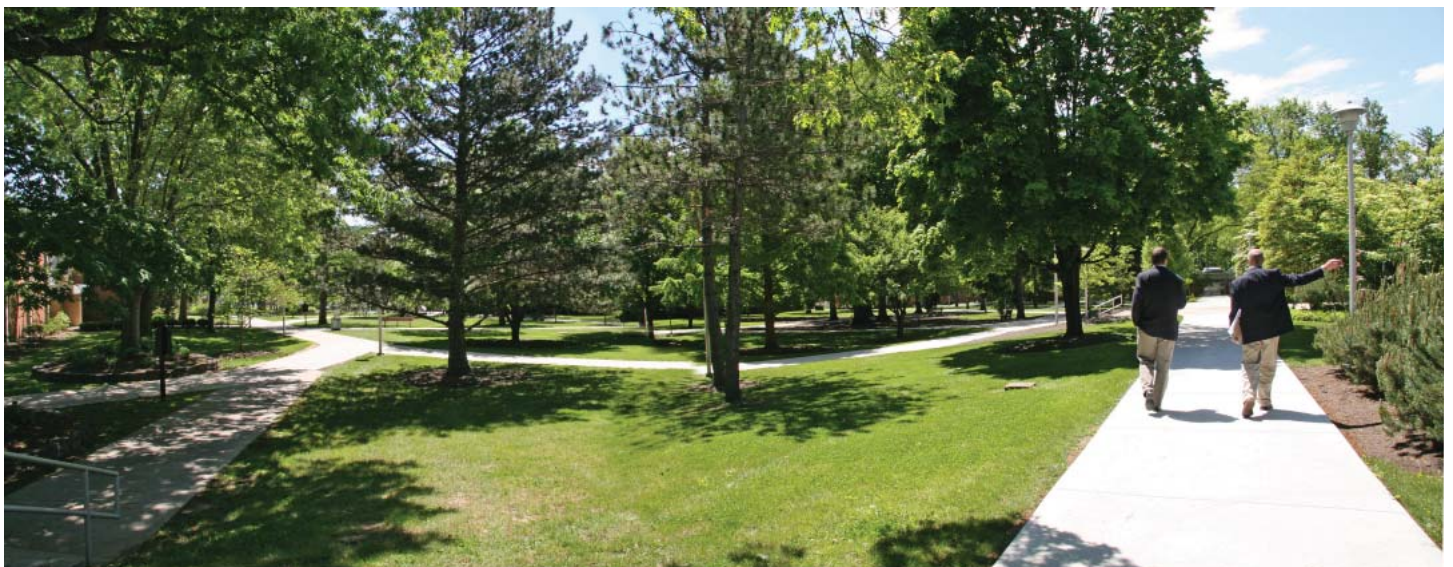

Pedestrian Circulation

Existing Conditions Inventory



The system of pedestrian walkways throughout the campus have evolved around natural obstacles like Spring Run and abundant mature trees. Routes appear to be adequate in location and number evidenced by the lack of unimproved pathways. ADA access needs have been accommodated sensitively for the most part though informal mulched surface pathways have been installed to access some site amenities. To make the paths fully accessible the surface material needs to be firmer. A compacted, crushed stone material would achieve the aesthetic objective of the path for all users including those with mobility impairments.

There are instances where paved surfaces are excessive. This condition contributes to increased water run off. It is noted that the campus has already begun a program to replace existing painted asphalt walks with new concrete material.

Unique Features

Existing Conditions Inventory



The aesthetic and experiential character of Penn State Altoona has evolved and remains true to the park heritage from which it comes. Abundant water features of various types, mature trees, wide lawn panels and meandering walkways contribute to the unique learning and recreational environment that is Penn State Altoona.

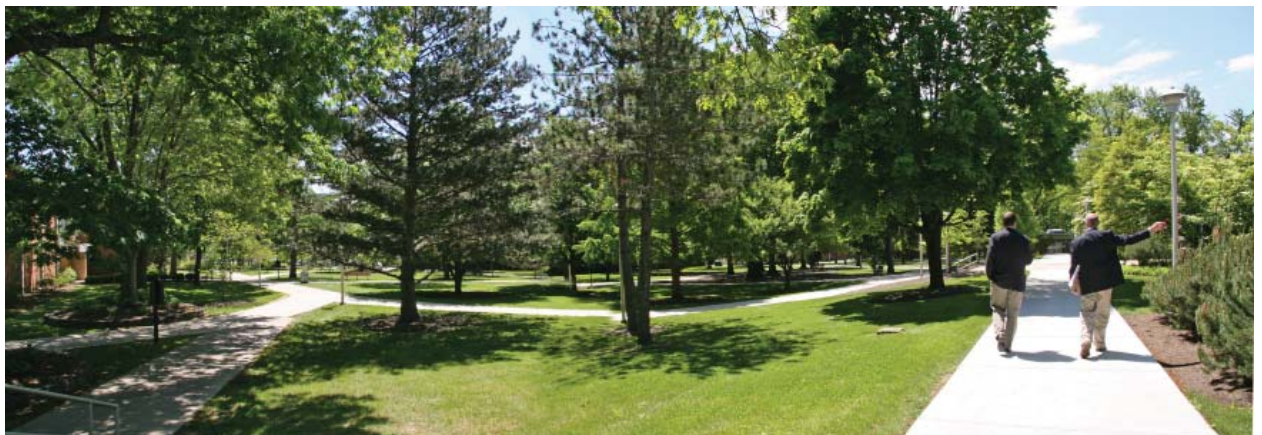

Improvement Concepts

The following figures describe and illustrate possible solutions to specific aesthetic and functional shortcomings on campus, most of which are addressable through the CEAP program. In addition to the recommendations that follow, there are routine maintenance tasks that will enhance the aesthetic appeal of campus. Suggestions include:

- ▶ Mulch landscape beds annually
- ▶ Eradicate weeds and other invasive vegetation
- ▶ Fertilize lawn areas
- ▶ Focus the use of annual and perennial plantings
- ▶ Re-seed lawn areas abutting sidewalks killed by deicing chemicals
- ▶ Seal and re-stripe paved areas
- ▶ Tree pruning and maintenance as recommended by University arborist

An implementation priority matrix has been prepared that lists improvement projects and recommends the order in which the concepts/projects could be executed. The implementation ranking is intended as a guideline for realizing the most significant impacts early in the plan implementation.

Location specific concepts/projects are keyed to the map with numbers corresponding to the listing on the matrix at the end of this report.

1A Awning Removal

Improvement Recommendation

The awning over the entrance to the Slep Student Center should be removed and standard University sign guidelines should be followed to identify the building.



Before



After

1B Window Stickers

Improvement Recommendation

The logo stickers on the windows of the Ralph and Helen Force Advanced Technology Center are used excessively without relevant need.

The ubiquitous presence of the mark diminishes its relevance as an identifier of Penn State. In addition, some of the appliques are peeling from the glass surface.

Decals should be removed from the windows.



1c Building Entrance Treatment

Improvement Recommendation

The entrances to many campus buildings should be enhanced to convey a more welcoming feeling. This is the point where students, faculty, staff, and visitors are in closest contact with the campus architecture.

Possible treatments include new doors, powerwashing of facades as needed, planters, standardized signage, new lighting, and complimentary landscaping.



Before



After

2A Site Furnishings

Improvement Recommendation



Site furnishings designed in a style “family” are aesthetically unifying. The examples shown here will compliment the contemporary architectural style present on the campus. Powder coated metal is attractive, comfortable and durable.

Planters should be appropriately sized for the space they occupy and be constructed of durable, quality material.



2B Picnic Tables

Improvement Recommendation



Before



After

As part of an effort to standardize and upgrade site furnishings to a level of design and quality befitting a college campus, it is recommended that picnic tables in the campus core be removed and/or replaced.

To provide supplemental seating in the landscape, benches should be strategically placed along walkways throughout campus.

Strategically located tables off of paved routes can facilitate informal social gathering.



2c

Post and Chain

Improvement Recommendation



Post and chain should be used sparingly to discourage pedestrian movement through planting areas. There are some areas on campus where existing post and chain do not appear to be serving a purpose and may, therefore, be removed.

Where post and chain is absolutely necessary, the University standard should be phased in.



UP campus standard for post and chain barrier.



3 Lighting

Improvement Recommendation

Replacement of any antiquated, inefficient pedestrian walkway and parking lot lighting is recommended.

Metal halide lamps in cut-off luminaires mounted to poles are recommended for pedestrian walkways.

High pressure sodium lamping is acceptable for parking lot lights. Color/finish for all fixtures should be consistent campus wide. Avoid the use of bollards due to vulnerability to snow removal operations and vandalism.



Parking Lot/Roadway Light



Site Light

4A Christodoulos Gazebo

Improvement Recommendation



Before

The gazebo occupies a prominent spot next to the east parking lot entrance to campus. Landscape plantings are sparse surrounding the gazebo and the wood chip paths leading to it are not universally accessible. A compacted crushed stone path would maintain the rustic character of the context while providing a suitable surface for handicapped users. The Penn State Dirt and Gravel Roads Studies "Trail Mix Specifications" should be used when specifying materials to assure a compact surface:

http://www.dirtandgravel.psu.edu/resources/dsa/trailmix_spec.pdf

A naturalistic planting palette that harmonizes with the existing canopy trees would be preferable.



After

4B Campus Clock

Improvement Recommendation

The wooden raised bed at the base of the campus clock between Eiche Library and the Misciagna Performing Arts Center appears residential in character.

Recommend the replacement of the wooden raised wall with supplemental landscape planting.



Before



After

4C Camouflage Meter

Improvement Recommendation



Before

The attempt to screen the existing utility meter at the entrance to Hawthorne Building using the masonry walls is unsuccessful from the parking lot approach.

Recommend the installation of evergreen landscape plant materials to complete the needed screen.



After

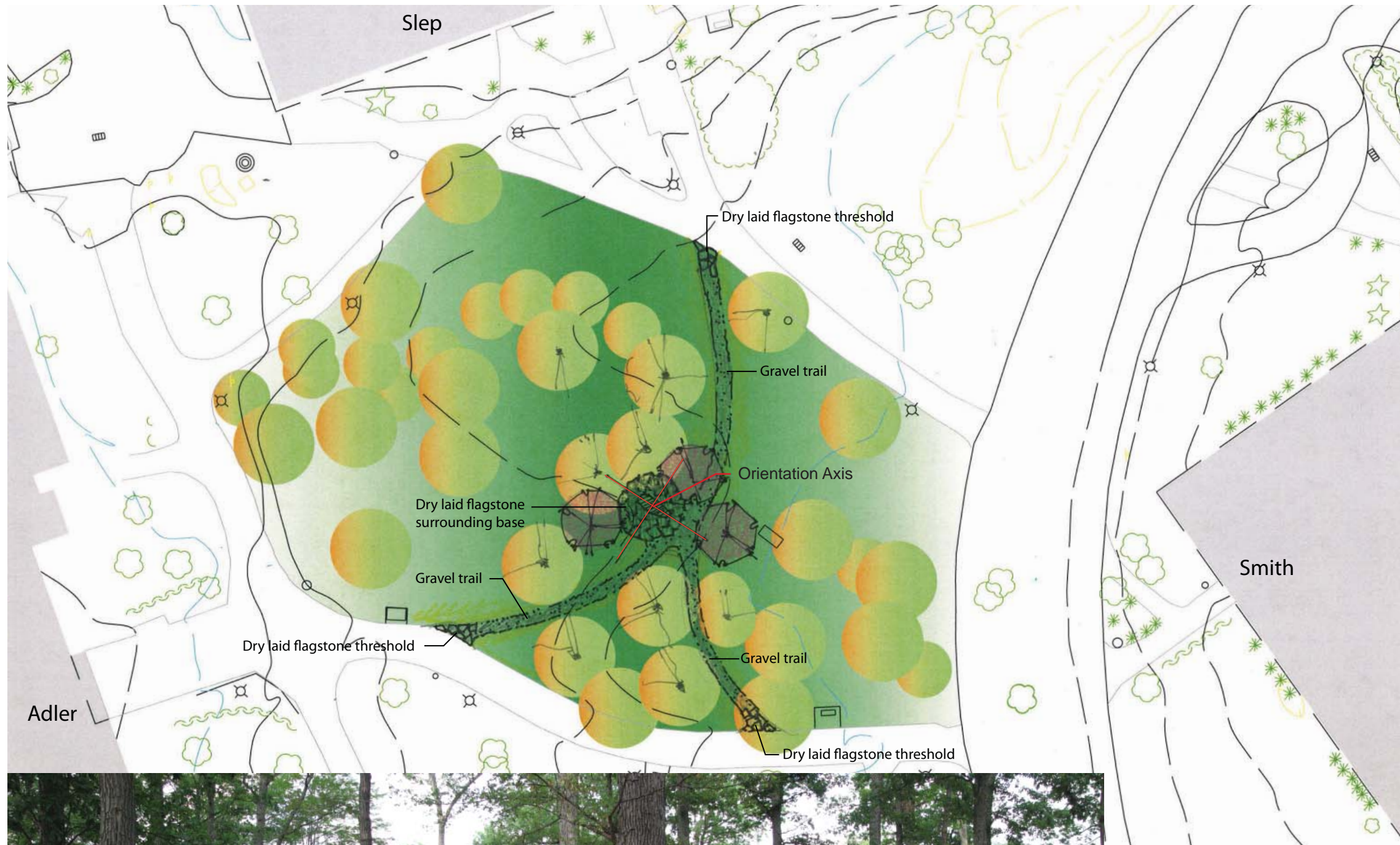

Lion Shrine ^{4D} Relocation

Improvement Recommendation

The opportunity exists to enhance the Nittany Lion by relocating it to a more central campus location. Improvements include soft surface pathways through the existing wooded area to a flagstone patio surrounding the statue. The plinth base under the statue should be slanted as is the original at University Park Campus. The planting of a few ornamental understory trees will add accent and scale to the new campus landmark.





Before



After



4E Camouflage Transformers

Improvement Recommendation

Opportunities exist across campus to screen utility boxes from view. Supplemental landscape plantings will not only obscure views but will add interest and beauty to the campus. An effort should be made to avoid "soldiering" screening plants around these fixtures, which can draw even more attention to the problem.

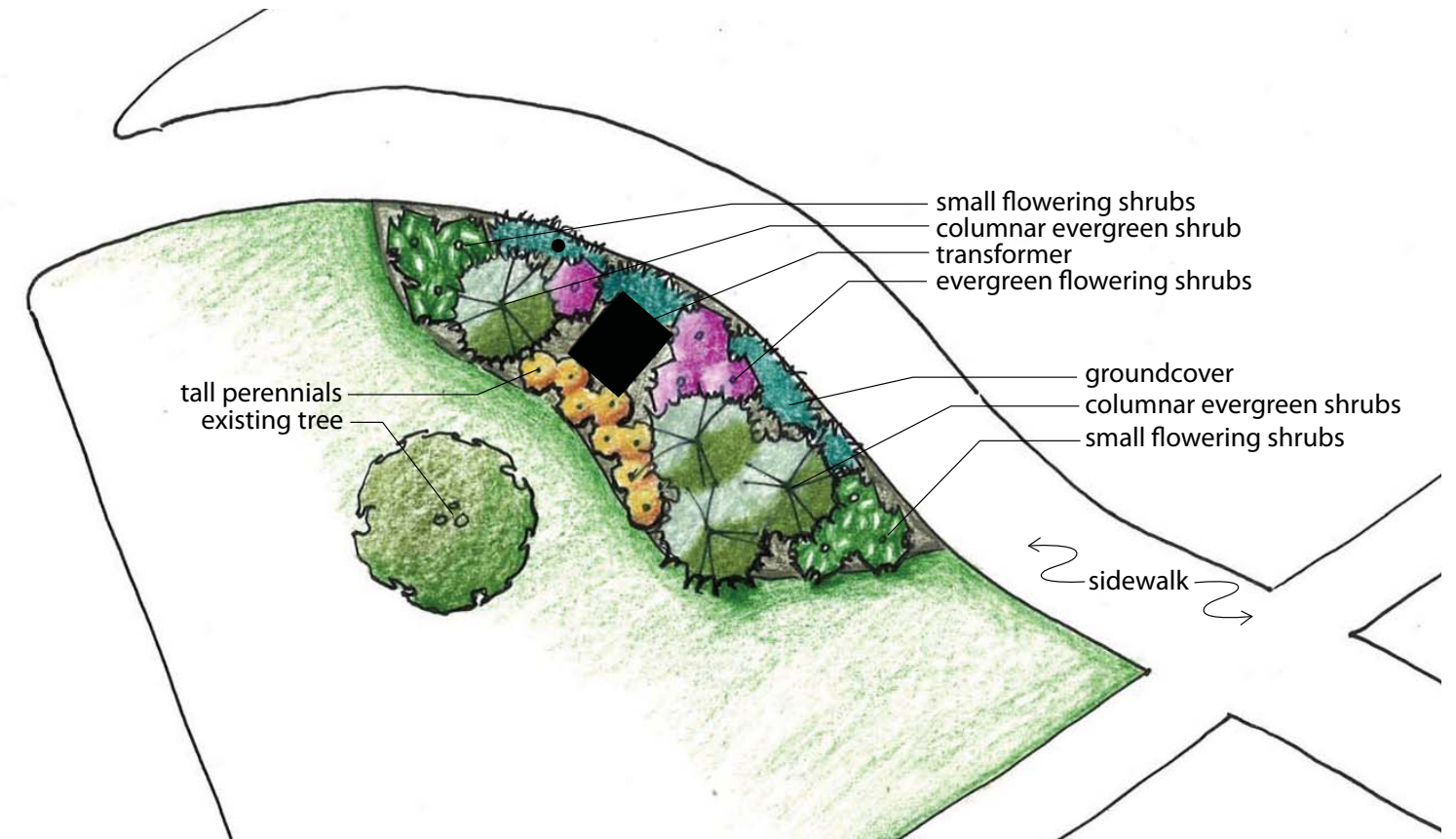

Suggested Conceptual Planting

4F

Ivyside Parklet

Improvement Recommendation

An opportunity exists to create a welcoming entrance to the campus at Ivyside Drive. The walk can be redirected to deposit pedestrians at a safer crossing point away from the main intersection. Landscaping and benches would create a pleasant social space for the University community as well as the neighborhood. The stone and iron fence would echo the materials of the entrance piers and Christodoulos gazebo and the university standard benches.

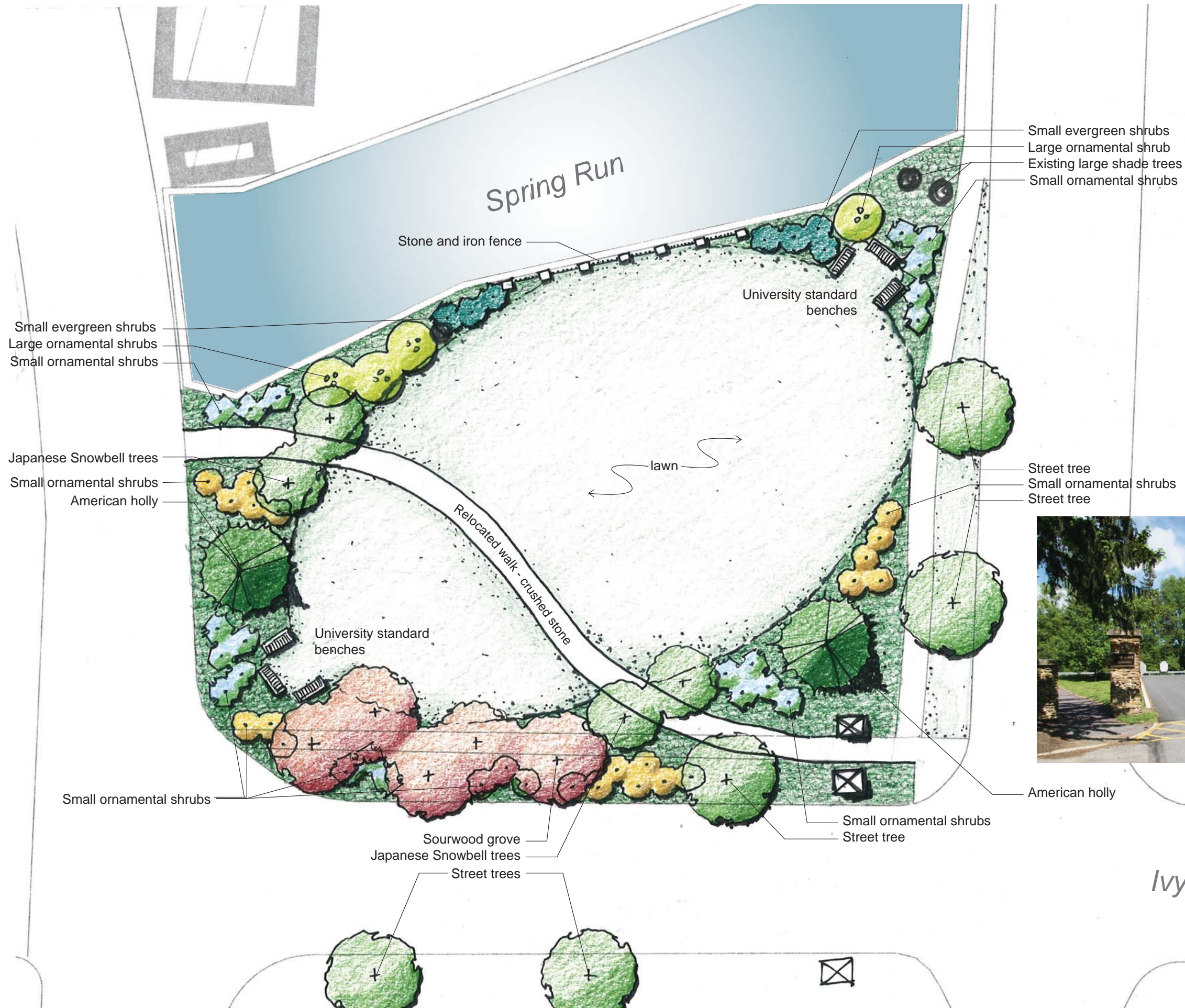

Existing campus entrance at Ivyside Drive

Ivyside Drive

Schneider Plaza Improvements

Improvement Recommendation

This patio area dedicated to a campus benefactor in 1987 is in need of renovation. The opportunity exists to provide ADA access to the patio and building as well as planting and furnishing upgrades to make the space more attractive and user friendly.



Existing Schneider Plaza



Existing Schneider Plaza

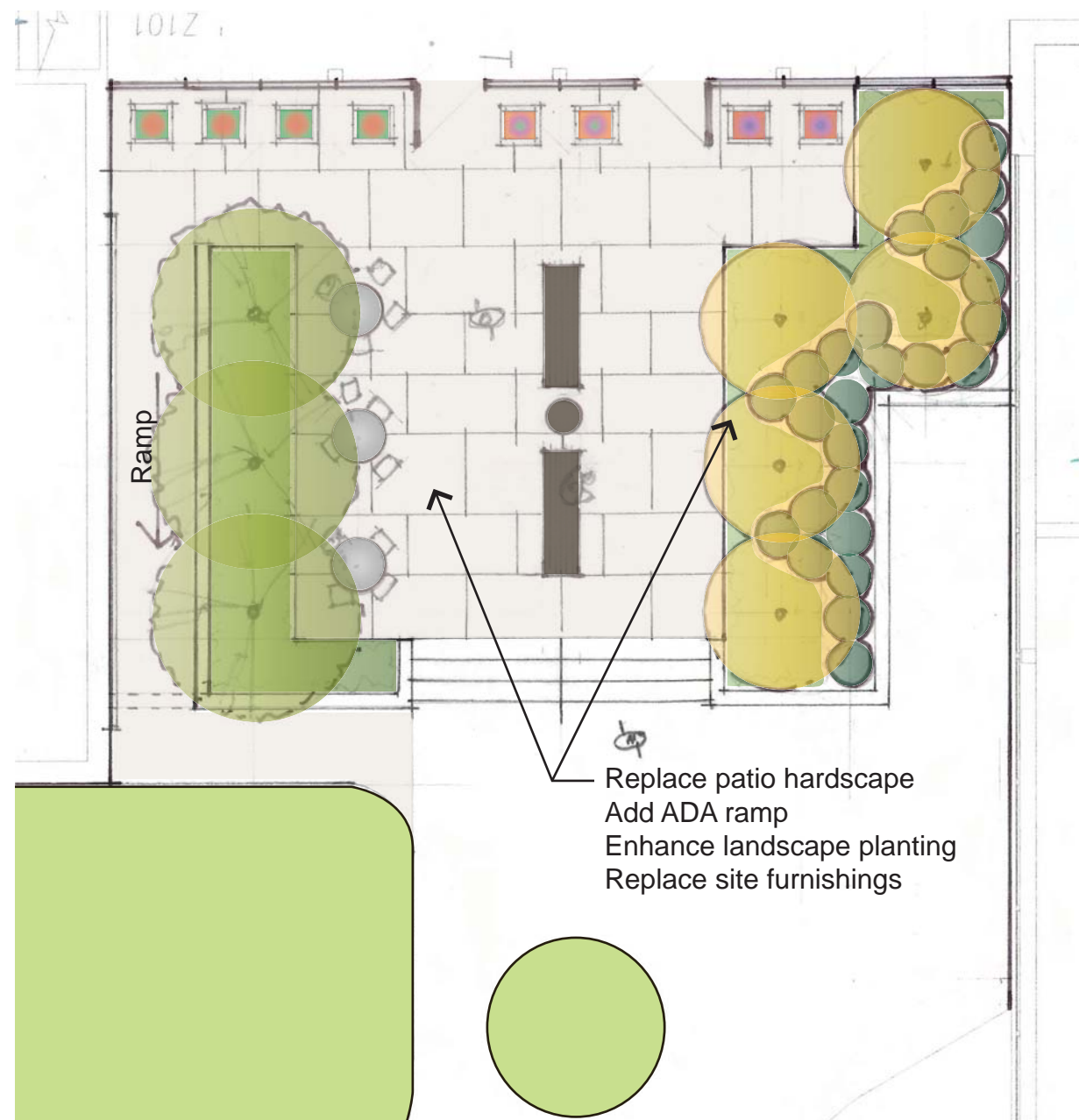

Port Sky Cafe Improvements

Improvement Recommendation

The existing outdoor patio at the Port Sky Cafe is too small to serve a campus community of this size. An expansion is recommended as is a sidewalk connection to the existing barbeque pavilion. A new adjoining patio is proposed for the north entrance. Surrounding landscaping would provide shade and enclosure and help to direct pedestrian traffic to sidewalks. The existing post and chain can be removed.



Existing under utilized area at cafe' entrance



Existing undersized cafe' patio



5A

Reduce Pavement

Improvement Recommendation

Overabundance of pavement contributes to excess water runoff and solar heat island effect. Green space is more visually pleasing than paved surfaces.

The opportunity exists to reduce pavement. Primary campus walkways should not exceed 10 feet in width. Minor walkways should be 8 feet in width to facilitate snow removal. It is also recommended that stamped and painted asphalt be removed and replaced with concrete.



Before



After



Before

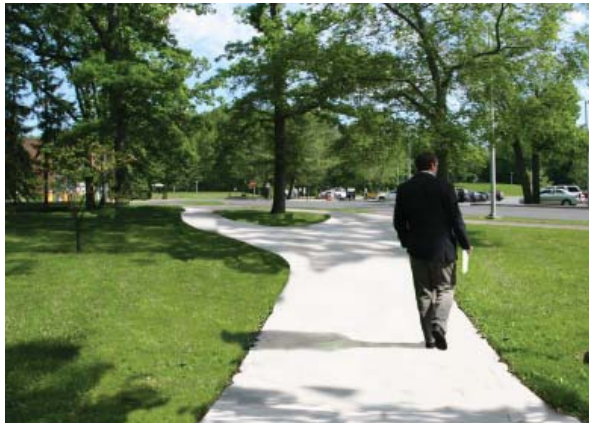

After

5B Paint / Repair Parking Gates

Improvement Recommendation

Penn State wishes to project a student centered and welcoming image to all who visit or use the campus. In lieu of removal and alternative parking control the entrance gates should be tempered by a more subtle paint scheme.



Before



After



Existing Condition



Existing Condition

5c

Misciagna Center/ Patrons Plaza Improvements

Improvement Recommendation

The plaza space at the main entrance to the performing arts center is in need of repair and enhancement. This highly visible public space is important to conveying a sense of quality and care to all University users.

The wall capstones and incised masonry sign are deteriorating due to age and possibly vandalism. The shrub plantings surrounding the plaza area would benefit from a renovation. Trash receptacles and ash urns should be replaced with new fixtures consistent with a campus standard.

Signage identifying the building does not comply with University standards. The identification sign should be redesigned to consider the standards and architectural design of the building itself.



Existing Plaza and Building Sign



Enhanced Plaza and Building Sign





Existing engineered stream edge

5D Access to Spring Run

Improvement Recommendation

Another way to strengthen the water theme at Penn State Altoona is to create an access point to Spring Run, which runs the entire length of the campus. This project could include an element of streambank restoration. An engineering study would clarify where the most feasible spot is for this type of project, but an inside turn of the waterway is the most likely location.

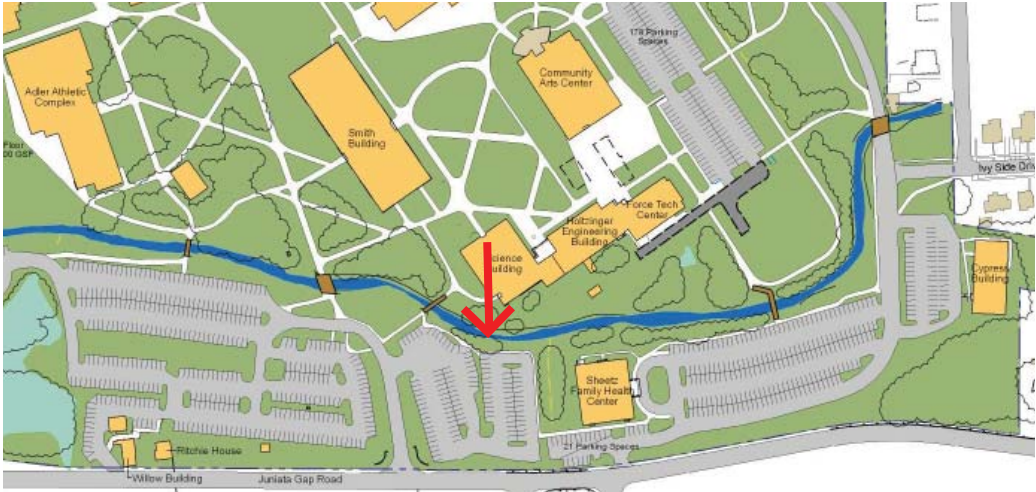

Possible location for an access point to Spring Run

Example of an access ramp with riparian plantings

Directional Sign

Improvement Recommendation

An existing panel sign occupies the green space adjacent to Juniata Gap Road at the south west corner of the campus.

This important corner location has value as a marker of the limits of the campus in addition to being a key wayfinding decision point.

Recommend removal of the existing sign and replacement with the University standard for vehicular directional signage at campus perimeter locations. The size, materials and graphics of the proposed sign integrate with other newly implemented signage to create a cohesive visual identity.



Existing sign at Juniata Gap and Rider Road intersection



West Face

East Face

SIGNAGE Vehicular Directional Signs (Perimeter Locations)

Signage Information

These Vehicular Directional Signs are located along the campus perimeter. They are larger and more substantial than those throughout the interior of the campus for two reasons:

- 1) to accommodate larger letters and increase readability in response to the speed of approaching vehicles, and
- 2) to achieve a more permanent appearance consistent with major entrance signage.

These non-illuminated painted aluminum signs use removable and changeable individual panels with a non-reflective background and reflective vinyl copy and graphics. The masonry base uses ashlar limestone and an Indiana limestone cap, and is designed to match the campus' existing wall patterns.

The typeface is Univers 67 Condensed Bold.

Colors		Signtype
Paint Matches Pantone 287	Vinyl Matches Pantone 420	DV.r.1 MASONRY BASE Vehicular Directional Sign Roadway Locations <small>Drawing Scale: 3/4" = 1'-0"</small> <small>(if spec sheet is 11x17)</small>
Pantone 425	Match ScotchBrite White	
	ScotchBrite Blue	

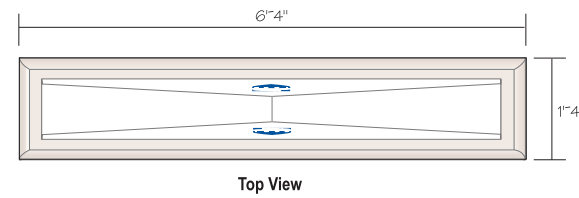

Top View

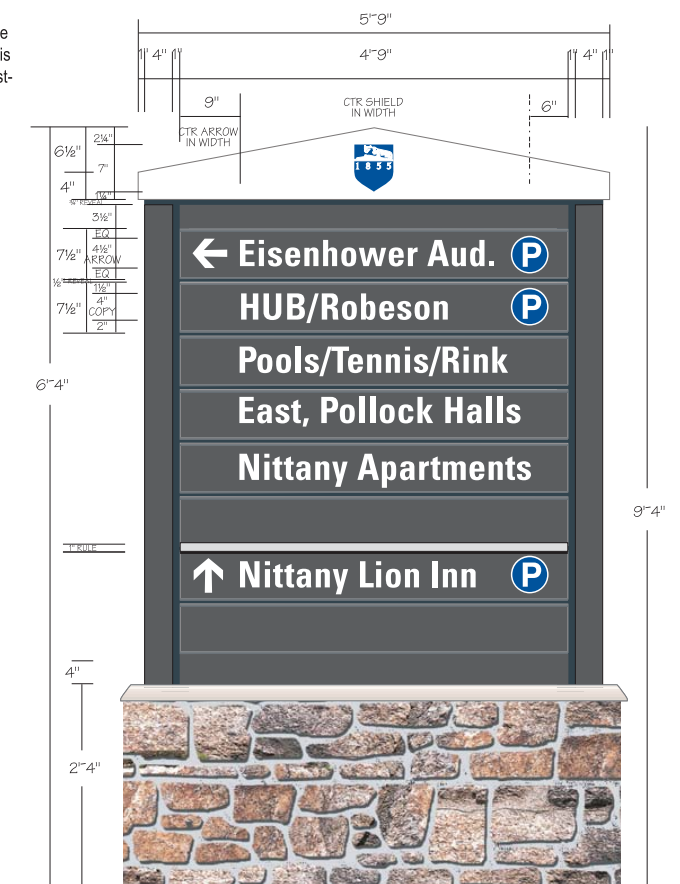

Standard Directional Sign

7^A Post Boards

Improvement Recommendation



The rustic character of lumber and shingle style exterior post boards is not compatible with the image of quality and permanence of a Penn State campus. Management of content is often irregular or inconsistent.

Space for managed posting of relevant notices should be limited to interior locations in common areas of buildings.

It is recommended that the existing exterior wooden post boards be removed from campus.



7B Lawn Ornamentation

Improvement Recommendation

Elements of whimsy in the landscape can be charming if used in moderation. With repetition of such a feature a theme may begin to develop. The campus should consider whether these ornamental sculptures are establishing a theme and if so, is this appropriate for an institution of higher learning. The recommendation of this CEAP is that the sculptures be congregated to one area of campus or removed altogether.



7C Relocate Elm Building Sculpture

Improvement Recommendation

The metal sculpture between Elm and Pine Buildings should be showcased in a more appropriate location such as the proposed Ivyside Parklet.



7D Handrail

Improvement Recommendation



The existing site steps in the south parking lot next to the main entrance do not have code required handrails in place. It is recommended that this deficiency be corrected.

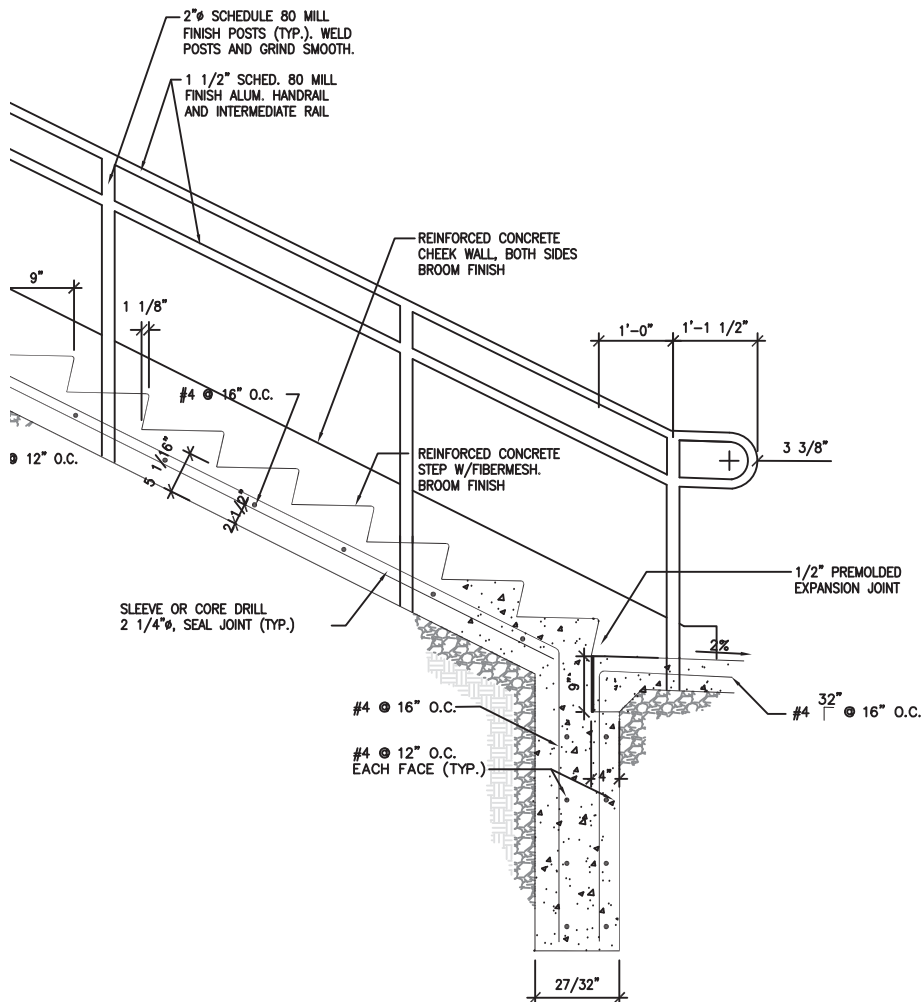

7^E Dumpster Screening

Improvement Recommendation

Waste and recycling receptacles are necessary for the management of disposable materials. The campus has done a good job of strategically locating a minimal number of unsightly receptacles and has screened them from view.

There is opportunity to further mitigate the negative aesthetic impact of waste collection by placing gates at access points to enclosures.



Before



After

Visually Link Spring Run Bridges

Improvement Recommendation

Water elements abound throughout the Altoona campus. One way to strengthen this theme is to create a consistent look to the four pedestrian bridges that span Spring Run.

Railing design should be consistent on all four bridges and color should be complementary to the surrounding vegetation. A subtle choice would be a natural dark brown. A bolder color choice would be a complementary red.

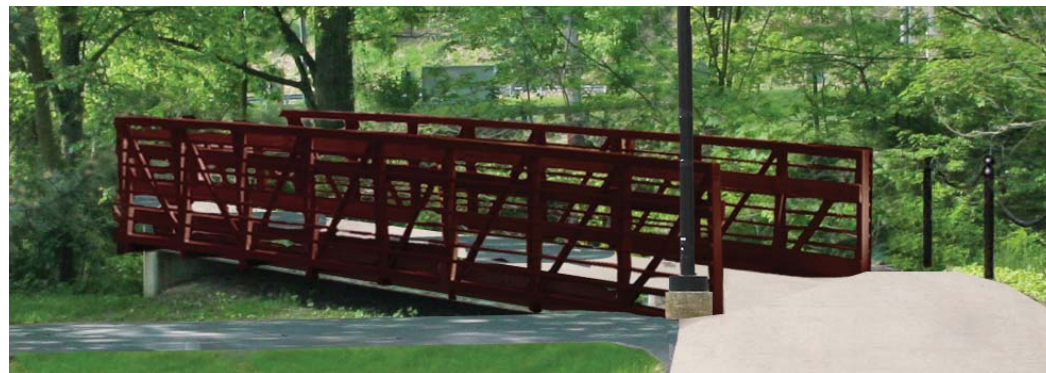

Existing Pedestrian Bridges

Proposed modifications

A more subtle color choice

Project Key Map

Penn State Altoona
Campus Exterior Architectural Plan
Project Prioritization Matrix
September-08

Proposed exterior improvement projects have been assessed with respect to the following criteria and assigned an implementation priority value.

Criteria include:

Visual Impact - degree to which the project improves the visual quality of the campus

Cost - level of capital investment required to implement the project (assumes no volunteer or donor contribution)

The projects with the highest numeric score should be given the highest priority for implementation

VISUAL IMPACT

- 1 - Little or no impact
- 2 - Minor Impact
- 3 - Moderate Impact
- 4 - Major Impact

COST

- 1 - Greater than \$25,000
- 2 - \$15,001 to \$25,000
- 3 - \$5,001 to \$15,000

#	PROJECT	IMPACT				COST			SCORE
		1	2	3	4	1	2	3	
1A	Awning Removal		X					X	6
1B	Window Stickers		X					X	5
1C	Building Entrance Treatment			X		X			5
2A	Site Furnishings (campus wide)			X		X			5
2B	Picnic Tables (campus wide)			X			X		6
2C	Post and Chain (campus wide)			X			X		6
3	Lighting (campus wide)			X		X			5
4A	Christodoylos Gazebo			X			X		6
4B	Campus Clock			X				X	7
4C	Camouflage Meter		X					X	5
4D	Lion Shrine Relocation			X		X			5
4E	Camouflage Transformers (campus wide)		X			X			3
4F	Ivyside Parklet			X		X			5
4G	Schneider Plaza Enhancements			X		X			5
4H	Port Sky Café Improvements			X		X			5
5A	Pavement Reduction (campus wide)			X		X			5
5B	Paint/Repair Parking Gates		X				X		5
5C	Misciagna Center/Patrons Plaza Improvements			X		X			5
5D	Spring Run Access			X			X		5
6	Directional Sign		X					X	6
7A	Post Boards			X				X	6
7B	Lawn Ornamentation (campus wide)			X				X	6
7C	Sculpture Relocation			X				X	6
7D	Handrail (campus wide)		X					X	4
7E	Dumpster Screening		X					X	4
7F	Spring Run Bridges			X				X	5

Note:
Cost ranges identified in this matrix are for planning purposes only. Actual costs will be dependent upon fully developed plans for the respective project. Some of the projects listed above can be broken down into smaller pieces and implemented in phases.

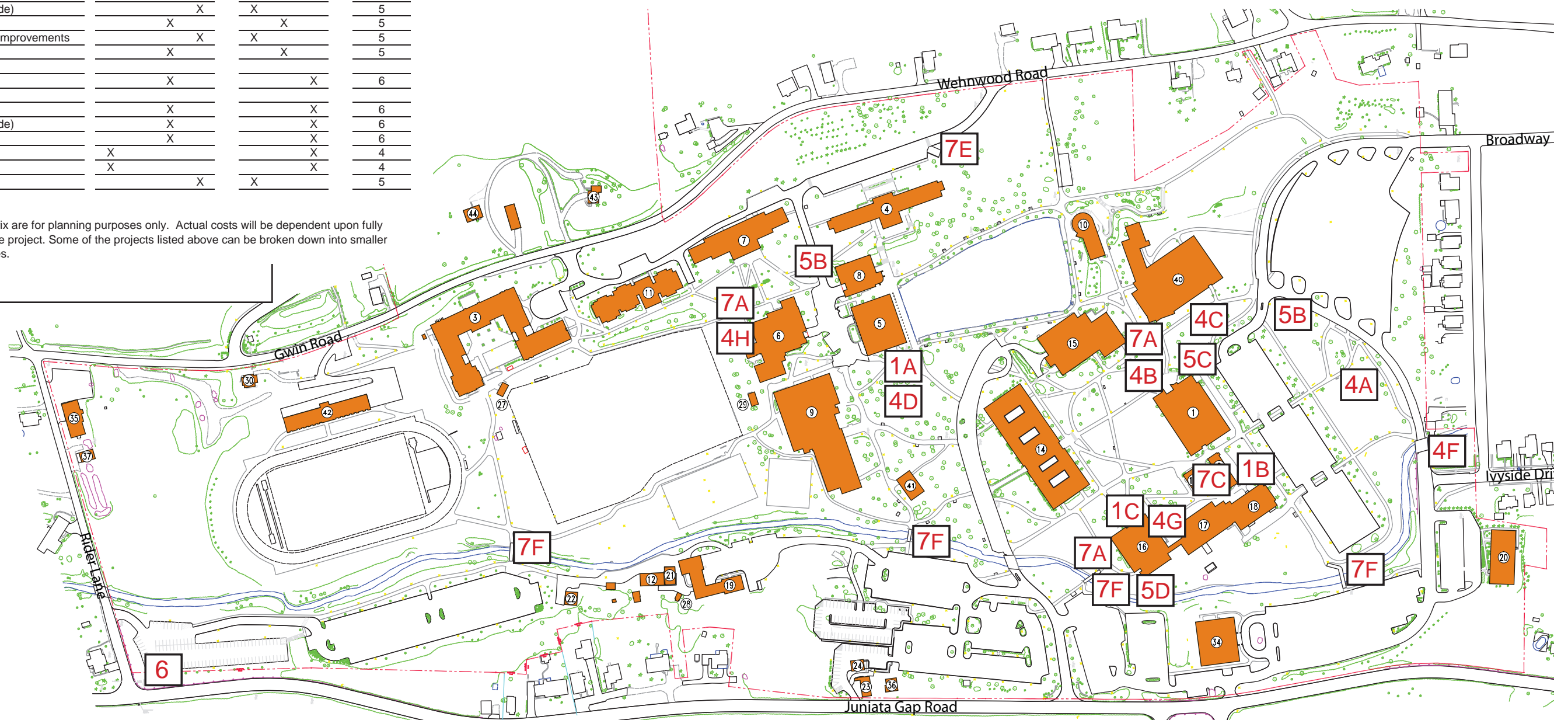

2A, 2B, 2C, 3, 4E, 5A, 7B, 7D Campus wide